

THE NEW VALUE FRONTIER

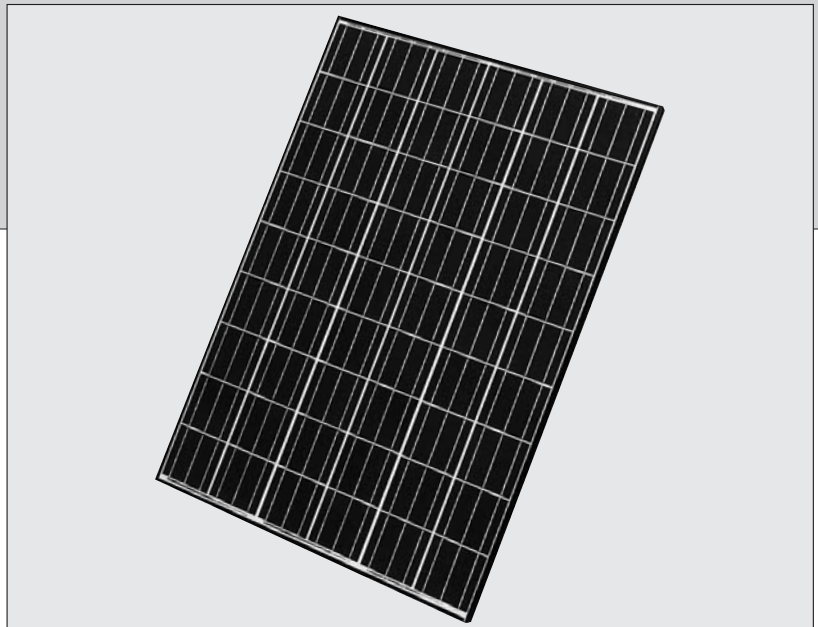

KC190GT

HIGH EFFICIENCY
MULTICRYSTAL
PHOTOVOLTAIC
MODULE



HIGHLIGHTS OF KYOCERA PHOTOVOLTAIC MODULES

Kyocera's advanced cell processing technology and automated production facilities produce a highly efficient multicrystal photovoltaic module.

The conversion efficiency of the Kyocera solar cell is over 16%.

These cells are encapsulated between a tempered glass cover and an EVA pottant with PVF back sheet to provide efficient protection from the severest environmental conditions.

The entire laminate is installed in an anodized aluminum frame to provide structural strength and ease of installation. Equipped with plug-in connectors.

APPLICATIONS

KC190GT is ideal for grid tie system applications.

- Residential roof top systems
- Large commercial grid tie systems
- Water Pumping systems
- High Voltage stand alone systems

QUALIFICATIONS

- **MODULE**
UL1703 certified

- **FACTORY**
ISO9001 and ISO14001

PERFORMANCE WARRANTY

1 year limited warranty on material and workmanship

25 year* limited warranty on power output

SPECIFICATIONS

■ Electrical Specifications

MODEL	KC190GT
Maximum Power	190Watts
Tolerance	+10% / -5%
Maximum Power Voltage	26.1Volts
Maximum Power Current	7.28Amps
Open Circuit Voltage	32.5Volts
Short-Circuit Current	8.08Amps
Length	1425mm (56.2in.)
Width	990mm (39.0in.)
Depth	36mm (1.4in.)
Weight	18.5kg (40.7lbs.)

■ Thermal parameters

Nominal Operating Cell Temperature	47°C
Isc Current temperature coefficient	(3.18×10 ⁻³) A/°C
Voc Voltage temperature coefficient	(-1.23×10 ⁻¹) V/°C

Note: The electrical specifications are under test conditions of Irradiance of 1kw/m², Spectrum of 1.5 air mass and cell temperature of 25°C

Kyocera reserves the right to modify these specifications without notice.

■ Physical Specifications

(Unit: mm)

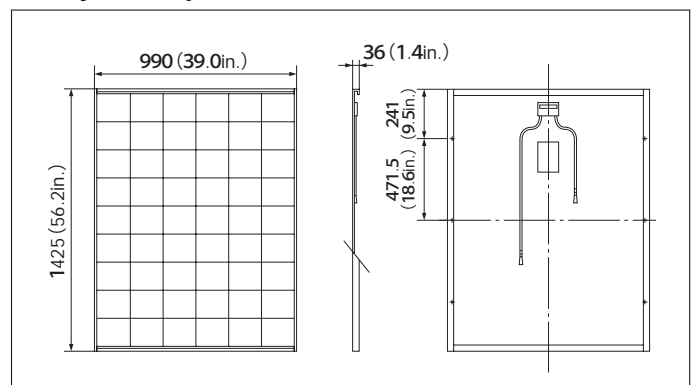

※(Long term output warranty shall guarantee that loss of output is not more than 10% of the minimum warranty value of the product specifications within 12 years and is not more than 20% within 25 years after the purchase of the product by customer. The output values shall be those measured under Kyocera standard measurement conditions. Regarding the warranty conditions in detail, please refer to Warranty issued by Kyocera.)

ELECTRICAL CHARACTERISTICS

Current-Voltage characteristics of Photovoltaic Module KC190GT at various cell temperatures

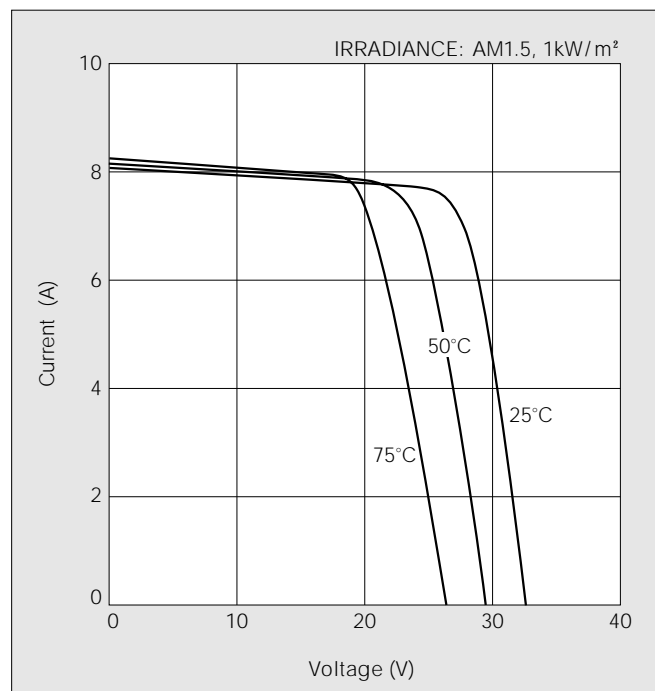

Current-Voltage characteristics of Photovoltaic Module KC190GT at various irradiance levels

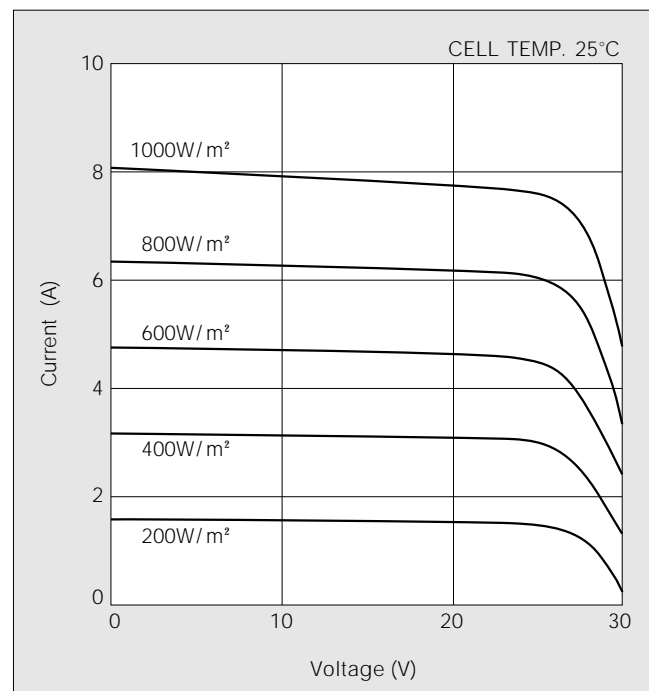

QUALITY ASSURANCE

Kyocera multicrystal photovoltaic modules exceed government specifications for the following tests.

- Thermal cycling test
- Thermal shock test
- Thermal/ Freezing and high humidity cycling test
- Electrical isolation test
- Hail impact test
- Mechanical, wind and twist loading test
- Salt mist test
- Light and water-exposure test
- Field exposure test

Please contact our office to obtain details without hesitation.



KYOCERA Corporation

■ KYOCERA Head Office

CORPORATE SOLAR ENERGY DIVISION
6 Takeda Tobadono-cho
Fushimi-ku, Kyoto
612-8501 Japan
Phone:(81)75-604-3476 Telefax:(81)75-604-3475
<http://www.kyocera.com>

● KYOCERA Solar, Inc.

7812 East Acoma Drive
Scottsdale, AZ 85260
Phone:(480)948-8003 or (800)223-9580 Telefax:(480)483-6431
<http://www.kyocerasolar.com>

● KYOCERA Solar do Brasil Ltda.

Energia Renovavel LTDA,
Rua Maurisio da Costa Faria, 85
22780-280, Recreio, Rio da Janeiro, Brazil
Phone:(55)21-2437-8525 Telefax:(55)21-2437-2338
<http://www.kyocerasolar.com.br>

● KYOCERA Solar Pty Ltd.

Cnr Forbes & Riverside Drive, West End,
QLD 4101, Australia
Phone:(61)7-3844-6686 Telefax:(61)7-3844-8569
<http://www.kyocerasolar.com.au/>

● KYOCERA Fineceramics GmbH

Fritz Muller strasse 107, D-73730 Esslingen, Germany
Phone:(49)711-9393417 Telefax:(49)711-9393450
<http://www.kyocerasolar.de/>

● KYOCERA Asia Pacific Pte. Ltd.

298 Tiong Bahru Road, #13-03/05
Central Plaza, Singapore 168730
Phone:(65)271-0500 Telefax:(65)271-0600

● KYOCERA Asia Pacific Ltd.

Room 803, Tower 1 South Seas Centre, 75 Mody Road,
Tsimshatsui East, Kowloon, Hong Kong
Phone:(852)2-7237183 Telefax:(852)2-7244501

● KYOCERA Asia Pacific Ltd. Taipei Office

10 Fl., No.66, Nanking West Road, Taipei, Taiwan
Phone:(886)2-2555-3609 Telefax:(886)2-2559-4131

● KYOCERA(Tianjin) Sales & Trading Corporation

Binjiang International Hotel 1106
105 Jianshe Road Heping Dist. Tianjin China
Tel:(22)2331-8590 Fax:(22)2330-6276